

ACO DN 100 Junior Cellar Gully

with double backflow safety valve and emergency seal for wastewater free of faeces
Certified to EN 13564-2 (Type 5)

Junior cellar gully
with plastic grating, Class K3
(Item no: 2130.00.77)



Junior cellar gully
with Quadrato stainless steel
grating
Class L15 (Item No: 2130.00.87)



To ensure safe and professional usage, read the Instructions for Use carefully, provide these to the end user and keep them safely until the product is finally disposed of.

0173.02.29_V1_GB Translation of the original instructions



Data for Cellar Gully

Intended Use

When wastewater sewers become overloaded, e.g. following heavy rain, blockages or pumping station failures, a backflow of wastewater can cause damage to buildings.

The ACO Junior Cellar Gully with a removable backflow safety valve that conforms to DIN EN 13564-1 (Type 5) is intended for installation in the floors of non-commercial cellar premises (floor plates), and drains wastewater free of faeces into the sewerage system.

The built-in backflow safety valve prevents wastewater flowing back in from the sewerage system.

Approved load classes according to DIN EN 1253-1

Load class	Installation areas
K3	Traffic-free surfaces with a maximum permitted load of up to 300 kg.
L15	Surfaces with a maximum permitted load of up to 1,500 kg.

Installation requirements:

- No threat to high-value items
- No threat to persons in the event of flooding
- Gradient from the drainage line into the sewerage system

Hazardous substances may not be drained:

- solids, e.g. ashes, glass, sand, textiles, cardboard
- corrosive substances, e.g. acids, lyes, salts
- foaming substances, e.g. cleaning materials, rinsing and washing agents in large quantities
- poisons, e.g. plant protection and pest control agents
- oils and fats

Qualification of Personnel

Skills required for installation and testing:

- Knowledge of buildings and building services
- Assessment of wastewater technology applications
- Construction of recesses (on-site building work)
- Installation of drainage lines

Product features

- Ideal for renovation projects thanks to compact product size
- Tool-free fitting and removal of foul air trap (= sludge bucket) and backflow units
- Shut-off unit with two backflow flaps and a manual locking emergency seal
- Flow rate: 1.4 l/s
- Load classes: Gully with plastic grating: K3
Gully with stainless steel grating: L15
- Weight incl. grating: Gully with plastic grating 1.2 kg
Gully with stainless steel grating: 2.5 kg
- Frame dimensions: 197 x 197 mm
- Socket inclination: 1.5°
- Max. temperature: 93 °C (briefly)

Personal Protective Equipment

Depending on the scope of the required building measures and the local circumstances, personal protective equipment may be required, e.g. a helmet where there are low ceilings.

Dimensions

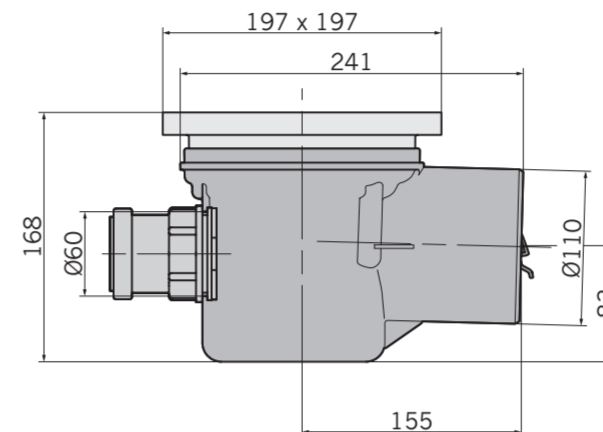

Disposal

Incorrect disposal is an environmental hazard. Respect regional disposal regulations.

- The Junior Cellar Gully is made from plastic which can be recycled (PP)
- The Quadrato designer grating is made from high-quality stainless steel

Guarantee

For information on warranties see our "General Terms and Conditions", at

<http://www.aco-haustechnik.de/agb>

Service

For any questions about the cellar gully and for further information, our ACO Service team looks forward to hearing from you.

ACO Service Tel: +49 3 69 65 / 81 9-0
Im Gewerbepark 11c Fax: +49 3 69 65 / 81 9-3 61
36457 Stadtlengsfeld service@aco.de

Accessories

Illustration	Description	Description	Item no.
	DN 50 inlet socket	for lateral inlet	2410.00.04
	Extension Structure height: 130 mm	for deeper installation	2040.00.06
	Backflow unit	replacement	2120.00.00
	Test pipe	for testing	6010.00.15

For other accessory parts see our "Product catalogue" at <http://www.aco-haustechnik.de>

Installation Instructions

To replace an existing gully a recess of 250 x 400 mm is required.

The following example describes the initial installation of a cellar gully with an extension and a DN 50 lateral inlet, e.g. to connect the wastewater drainage of showers or washing machines, including the building work required.

This approach is intended to explain the principles and can vary for each individual installation.

When deciding on the installation site, remember that this needs to be easily accessible for later testing and e.g. must not be blocked off by furniture.

- Remove top section. (1).
- Pull foul air trap out from the gully body (2).
- Check if the emergency seal is open, if necessary open it. Chap. "Operating Instructions".

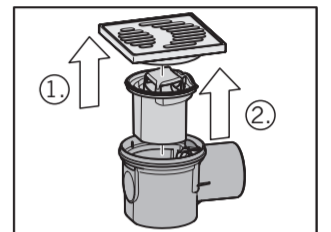

Install a DN 50 lateral inlet:

- Carefully drill a hole in the casing using a 60 mm diameter core hole bit, on the opposite side to the gully casing socket (location is marked).
- Separate the connection elements from each other.
- Thread connection part (1) from inside through the bored hole (1) and screw into connection part (2).

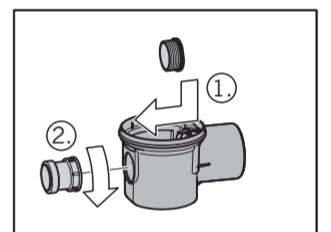
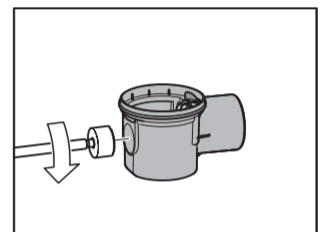

- Insert the gully body into the floor.
- Connect the DN 50 lateral inlet (1) and drainage line (2) to the gully body.

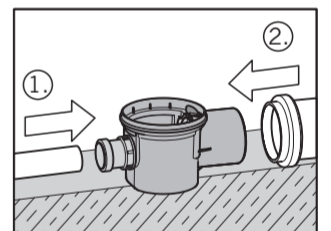

- Grease the foul air trap and insert into the gully body (snaps into place).

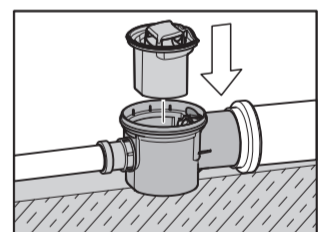

Install extension:

- Insert the extension into the gully body, if necessary cut to size using a saw and debur sawn edges.

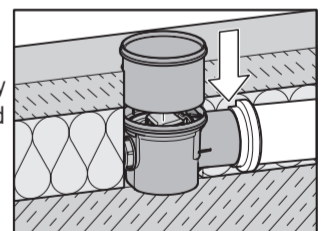

- Place the top section on top of the extension.

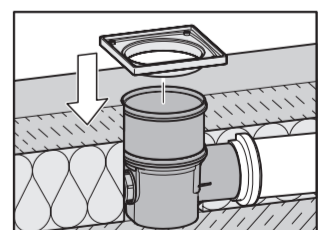

Lay floor covering, e.g. floor tiles:

Top section can be turned in all directions to align correctly with the tiles.

- Apply the foundations (e.g. plaster, screed, file adhesive). Follow the instructions of the manufacturer.
- Lay tiles.
- Seal around top section with permanently elastic sealant, e.g. with silicon.

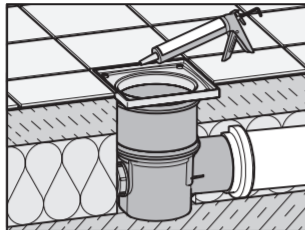
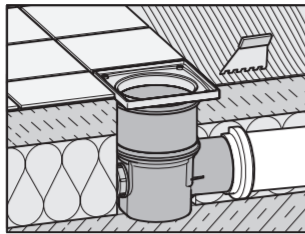

- Replace grating (1).
- Fill the cellar gully with clean water (2).

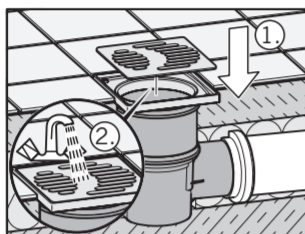

Operating Instructions

No intervention is needed when functioning normally.

In the event of a severe backflow, e.g. extremely heavy rainfall or of a lengthy absence, e.g. a holiday, the emergency seal should be closed. This means that wastewater and other water will not be drained from any connected inlets.

Closing emergency seal:

- Remove grating.

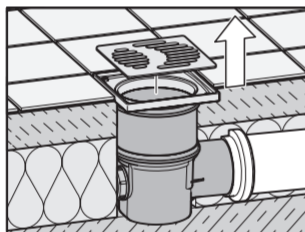

- Turn the red lever into position 1. The backflow unit's inlet flap (emergency seal) is now closed.

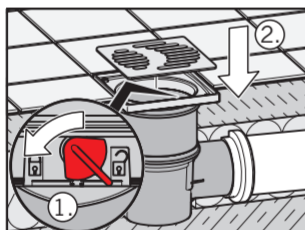

- Replace grating (2).

Opening emergency seal:

- Remove grating.

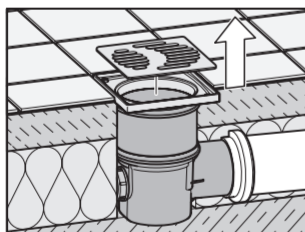

- Turn the red lever into position 2. The backflow unit's inlet flap (emergency seal) is now open.

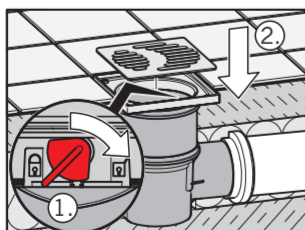

- Replace grating (2).

Monthly Tests

Check the cellar gully once a month, Chap. "Qualification of Personnel".

Check foul air trap:

- Remove grating (1).
- Pull foul air trap out from the gully body (2).

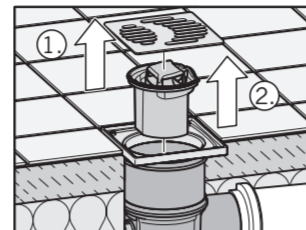

- Empty foul air trap, clean and check for visible damage (1).

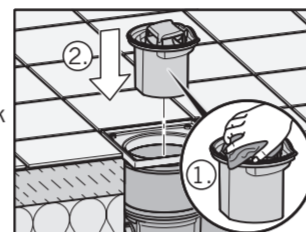

- Insert the foul air trap back into the gully body (snaps into place) (2).

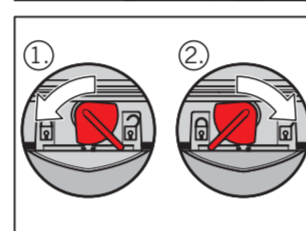

Check emergency seal:

The emergency seal must be easy to activate.

- Turn the red lever into position 1 (1).
- Turn the red lever into position 2 (2).

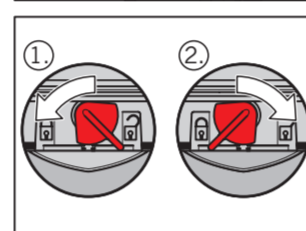

If the emergency seal cannot be activated correctly and easily, uninstall the backflow unit and clean and grease it. Often bulky deposits will be the cause.

Procedure, Chap. "Six-monthly Tests".

Replace the backflow unit if it still does not function correctly.

- Replace grating (1).
- Fill the cellar gully with clean water (2).

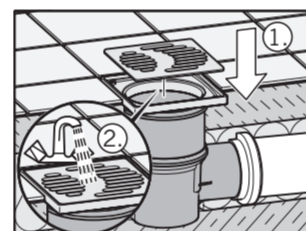

Six-monthly Tests

Have the cellar gully checked every 6 months by experts, Chap. "Qualification of Personnel". If in doubt ask for expert assistance.

The test includes simulating a backflow using a test pipe, Chap. "Accessories" This tests the functioning of the self-activated seals.

Document tests, e.g. to provide evidence in the case of an insurance claim.

For all processes, always do the following:

- Remove all dirt and deposits
- Replace damaged backflow units
- Grease all moving parts

Uninstall parts for testing:

- Remove grating.
- Pull foul air trap out from the gully body.

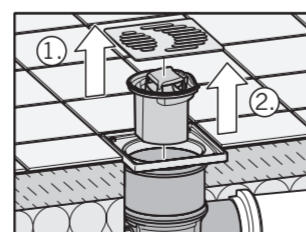

- Push the red handle on the backflow unit upwards.

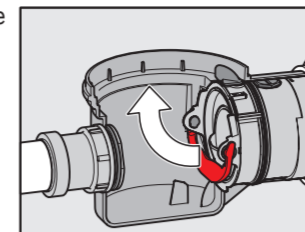

- Using the red handle first pull the backflow unit horizontally out of the connector (1) and then upwards out of the gully body (2).

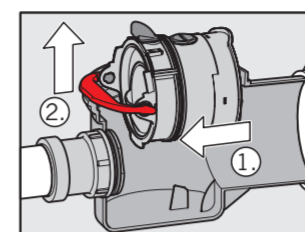

Check seal:

- Push the red locking lever on the backflow unit upwards as far as possible.

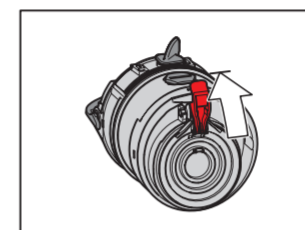

- Turn the red lever on the emergency seal to position 1.

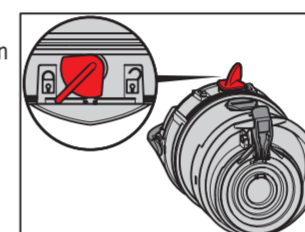

- Unscrew the red locking screw from the backflow unit.

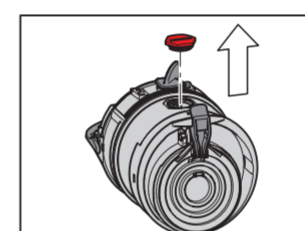

- Screw the test pipe into the opening (1).
- Fill the test pipe with clean water (2). The markings on the test pipe indicate the volume of liquid.
- Top up with water if the level of the liquid drops.

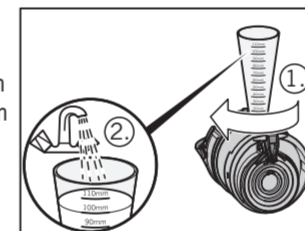

The backflow unit is sufficiently well sealed if within 10 minutes less than 500 ml (0.5 l) of water has been used to top up.

If this is not the case, clean the backflow unit. Often bulky deposits will be the cause.

Repeat the test with the test pipe.

Replace the backflow unit if within 10 minutes more than 500 ml (0.5 l) of water still has to be used to top up.

Reinstall parts after testing:

- Unscrew the test pipe from the backflow unit.
- Screw the red locking screw into the opening (1).
- Push the red locking lever on the backflow unit downwards as far as possible (2).

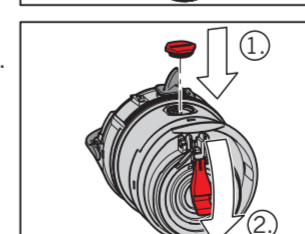
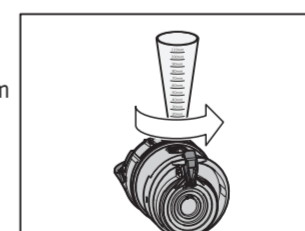

- Grease the backflow unit.
- Using the red handle first lower the backflow unit into the cellar gully (1), then move it horizontally into the connector (2).

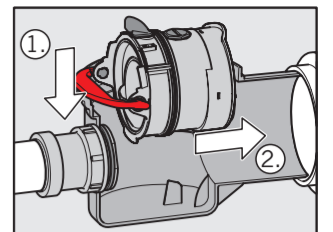

- Push the red handle on the backflow unit downwards as far as possible (1).
- Continue to push the backflow unit horizontally into the connection as far as possible (clicks into place) (2).
- Grease the foul air trap.
- Insert the foul air trap back into the gully body (snaps into place).

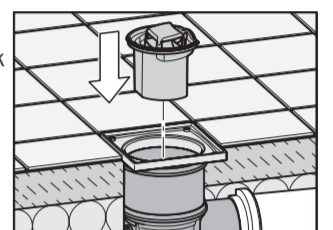
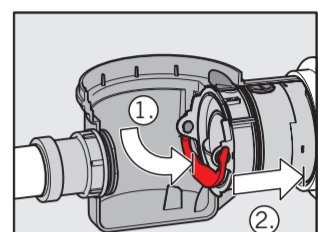

- Replace grating (1).
- Fill the cellar gully with clean water (2).

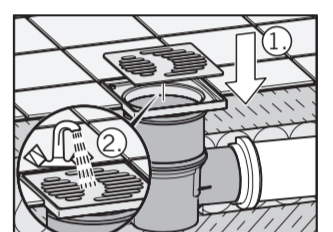

ACO Passavant GmbH

Im Gewerbepark 11c
D 36457 Stadtlengsfeld
Tel.: + 49 36965 819-0
Fax: + 49 36965 819-361

www.aco-haustechnik.de

ACO. The future of drainage.

