

Load class	Typ	Art.-Nr.	
		antracyt	natural
D 400	0.0	135001	416986

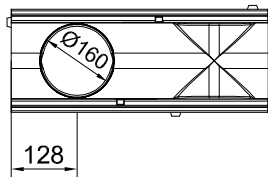

Access units	H (mm)	Art.-Nr.
Typ 0.1	280	416989
Typ 0.2	280	416985

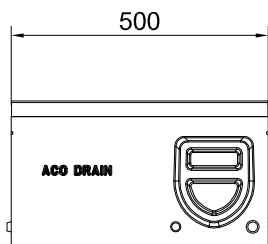
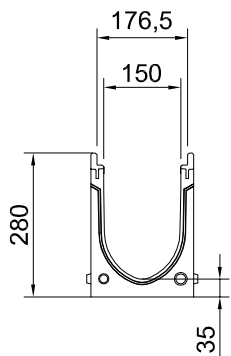
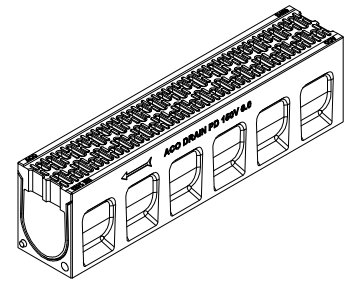
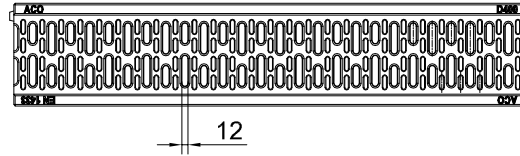
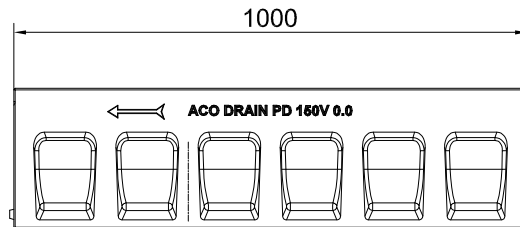
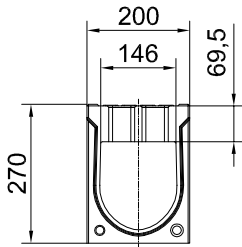
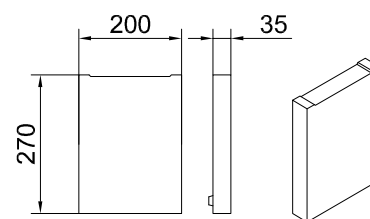
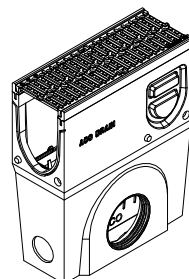
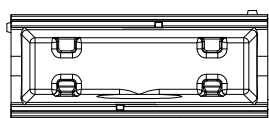
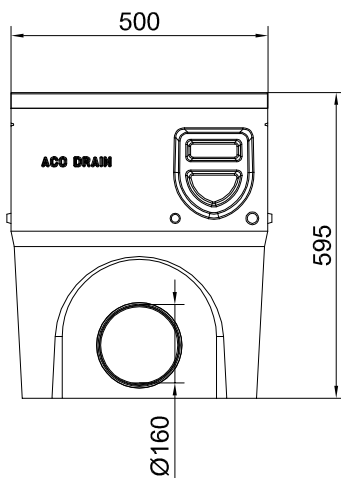
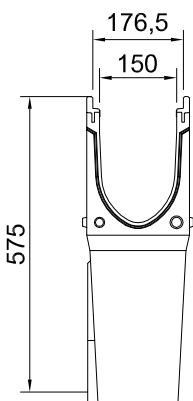
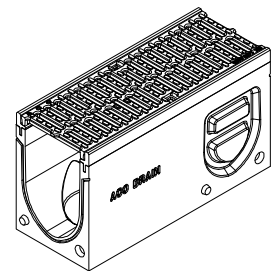
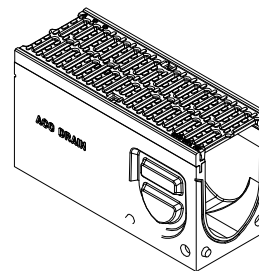

Art.-Nr.	
antracyt	natural
413137	416987

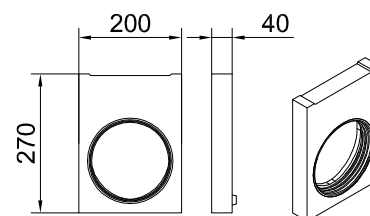

Art.-Nr.	
antracyt	natural
413138	416988

Art.-Nr.	
Outlet DN/OD 160	416990

System line drain:

Monoblock PD 150V



ACO Elementy Budowlane Sp. z o. o.
Ląjski, ul. Fabryczna 5 Tel.: 0-48 22 76 70 500
05-119 Legionowo Fax: 0-48 22 76 70 513

March 2015

www.aco.pl

Prepared: mrg inż. Jarosław Maślany