

Nadstawki do separatorów Oleopator-P-FST / Oleopator-BYPASS-P-FST

klasa obciążenia A15

nr kat. 3301.34.01

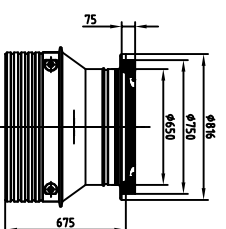

nr kat. 3301.34.02

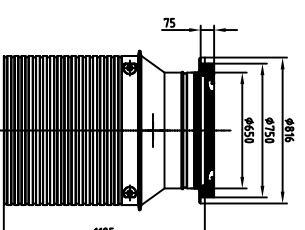

nr kat. 3301.34.03

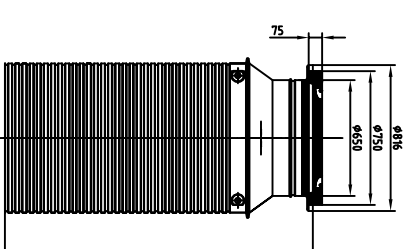

klasa obciążenia B125

nr kat. 3301.35.01

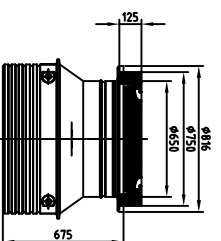

nr kat. 3301.35.02

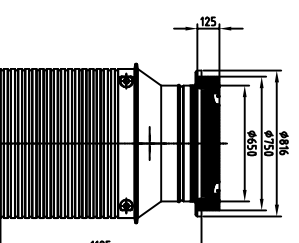

nr kat. 3301.35.03

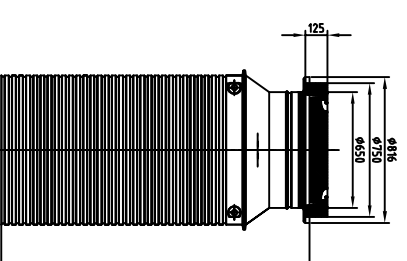

klasa obciążenia D400

nr kat. 3301.37.00

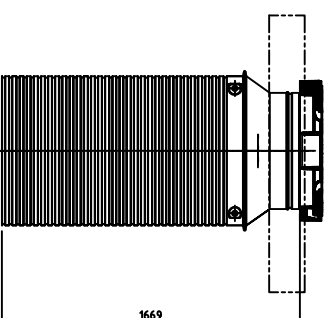

nr kat. 3301.36.00

